



StoneVic International Inc.
Atlanta, GA

Office: 1.844.777.5229
www.ThinSlabz.com

Gene Skeen | (e) Gene@svkusa.com
Daniel Skeen | (e) Daniel@svkusa.com
Ashley Skeen | (e) Ashley@svkusa.com



StoneVic International Inc.
THINSLABZ[®]

**The Future of
Stone is Here**[®]



Copyright © 2018 | StoneVic International Inc.

www.ThinSlabz.com

Copyright © 2018 | StoneVic International Inc.



THINSLABZ[®] Applications

StoneVic International Inc. is a National distributor of ultra thin laminated natural stone panels. Our ThinSlabz[®] are comprised from the highest quality blocks of marble, onyx, travertine, limestone & granite, which are then laminated with durable reinforced backers.

The total thickness of each ThinSlabz[®] is 8mm. By using advanced equipment and technology, we are able to slice the blocks into 3-7mm veneer pieces and then adhere different reinforced backers. This process allows for the panels to be strong, lightweight, flexible, durable and very easy to handle.

- Tub and Shower Surrounds
- Focal Walls
- Fireplaces
- Elevators
- Boats
- Wainscoting
- Airplanes

ThinSlabz[®] Backers/Applications

- Aluminum Composite Plastic (Interior)
- Transparent Fiberglass (Interior)
- Transparent PVC (Interior)
- Glass (Interior)
- Honeycomb (Interior/ Exterior)
- Ceramic (Interior/Exterior)





Thin
Lightweight
Flexible
Durable

PRODUCT ADVANTAGE



1/3=0.333 Material Weight

ThinSlabz® only require 1/6-1/3 of stone material compared to the traditional stone slab. Each ThinSlabz® sheet weighs approx. 2 lbs per square foot compared to traditional 2 CM slabs that weigh 12 lbs per square foot. The lightweight panels allow for easy transport and installation.



ECO Building Materials

ThinSlabz® provide a more sustainable surfacing material by:

- Reducing water and energy consumption
- Reducing raw material waste during production
- Reducing packaging materials
- Reducing transportation costs
- Increases the square footage of material per container.



100% Natural Surfacing

ThinSlabz® are fabricated with immaculate craftsmanship and only use the highest quality marble, onyx, granite, travertine & limestone selection. Most ThinSlabz® can be bookmatched from the same slab to provide an exceptional and unique design.

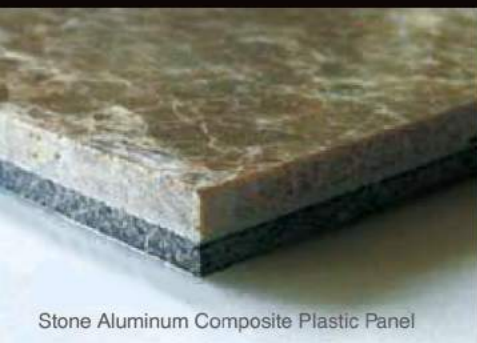

Stone Aluminum Composite Plastic Panel

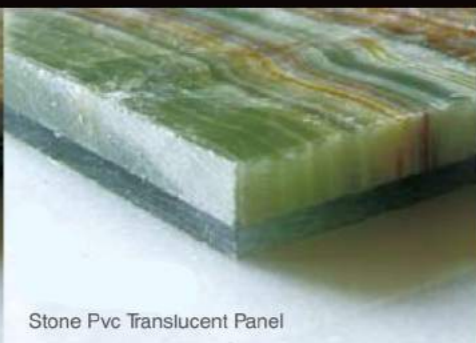

Stone Pvc Translucent Panel

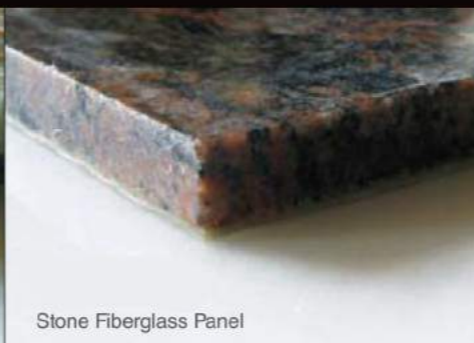

Stone Fiberglass Panel

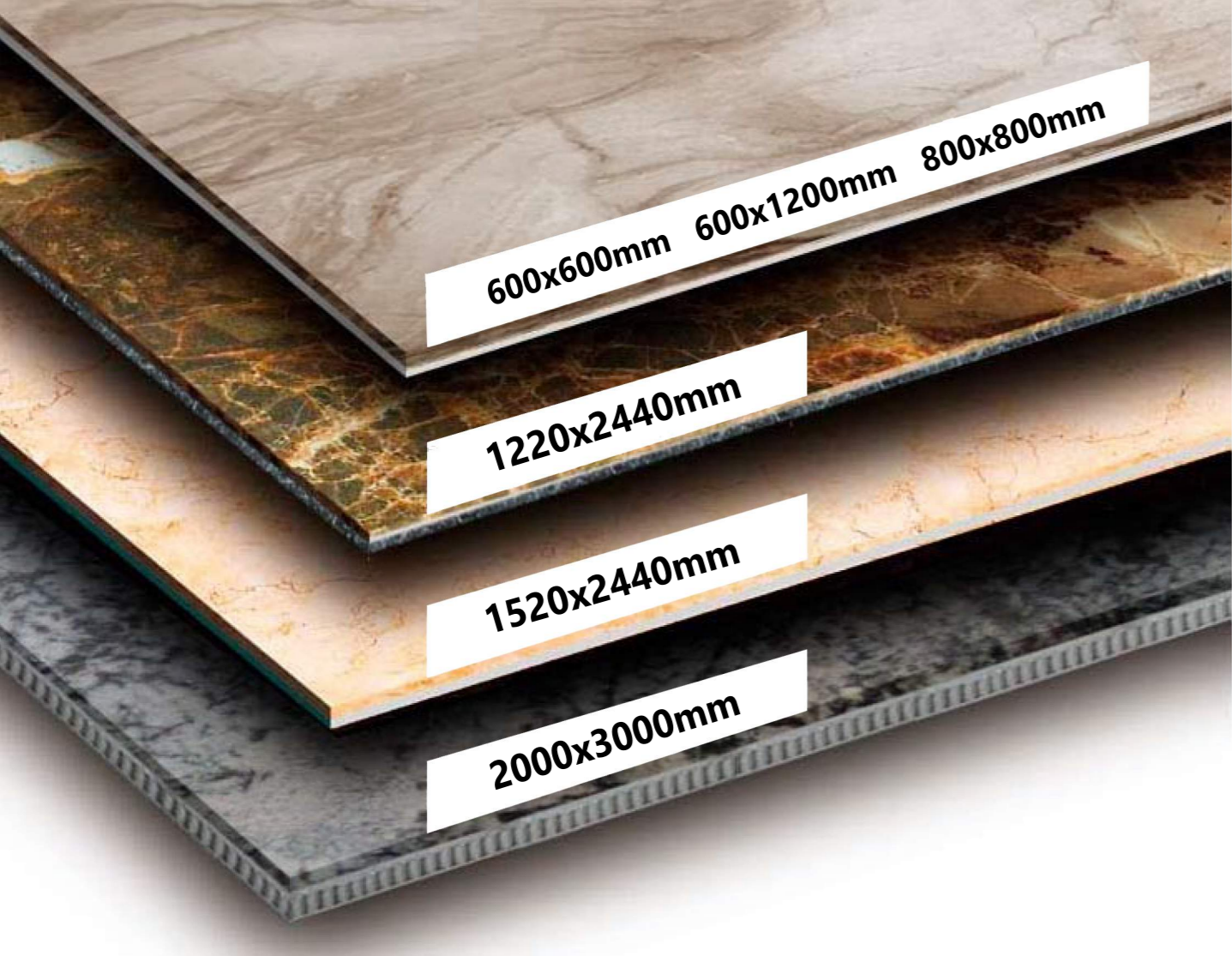

ThinSlabz® Stone Ceramic Composited Tile



3 mm of stone with 9-14mm porcelain backers. It is much stronger than natural stone itself. It is widely applied both in interior and exterior including floor application.

Thin Slabz® Stone Aluminum Composite Plastic Panel

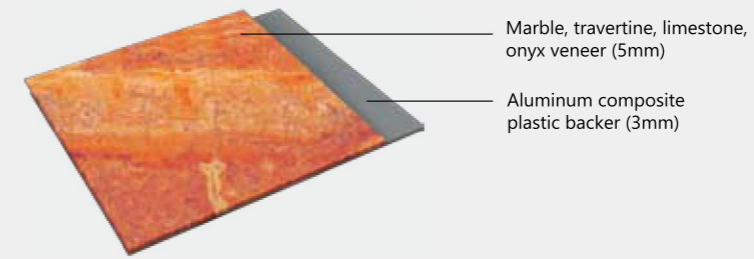

3 mm thick ACP laminate backing applied with 5 mm stone for a high-strength, lightweight and durable panel.

ThinSlabz® Stone Translucent Panel



Various thickness of engineered plastic laminated on onyx or translucent marble and granite. Used to keep the materials translucent character and adds a unique brightness to the project or space.

ThinSlabz® Stone Fiberglass Panel

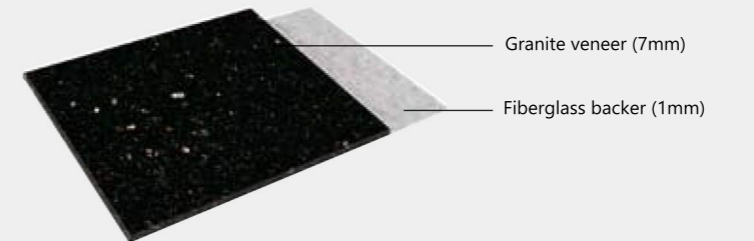

1 mm fiber glass cloth epoxy backing applied for a thin, strong and durable application.

ThinSlabz® Stone Honeycomb Composited Panel

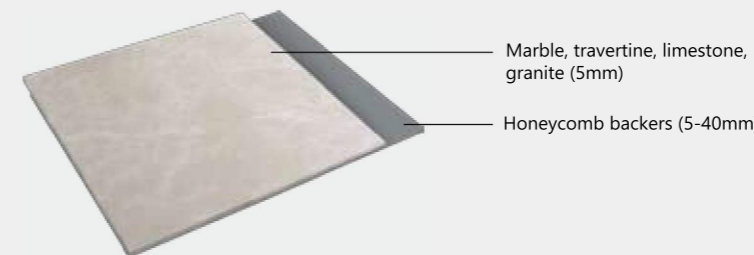

5mm of stone bonded with 40mm thick honeycomb backers. Allows for larger size, lighter weight and it is much stronger than natural stone itself. It is widely applied in both interior and exterior.

ThinSlabz® vs. Other Materials

	THICKNESS (APPROX)	WEIGHT (APPROX)	MAX SIZE (APPROX)	STABILITY	TRANSPORTATION	INSTALLATION
ThinSlabz®	8mm	3.5 lbs	60x90 in.	High Intensity, Strong, Durable, Flexible	Lightweight (saves \$ freight) Not easily broken	No Cement Adhesive Uses Less Grout Low Labor Cost Fast Installation
Traditional Stone	20mm	12 lbs	48x95 in.	Very Fragile	Heavyweight Easily Broken	Cement Adhesive Uses More Grout Higher Labor Costs Slow Installation
Ceramic	8-15mm	5.2 lbs	35x48 in.	Very Fragile	Heavyweight Easily Broken	Cement Adhesive Uses More Grout Higher Labor Costs Slow Installation





Bookmatched ThinSlabz[®] create a seamless, unique and unsurpassed visual design experience.





ThinSlabz® Shower Kits

Specially designed packages that offer specific sized Thin Panels for tub/shower surrounds along with customized trims, soap dishes, wall boxes, shower curbs & floor tiles in all of our premium natural stone materials.

	W1	W2	H
1	36"	36"	84"/96"
2	36"	48"	84"/96"
3	48"	48"	84"/96"
4	48"	60"	84"/96"

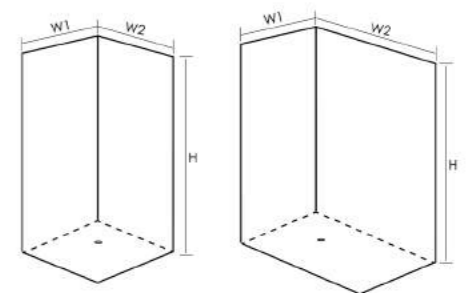



StoneVic International Inc. offers matching solid surface stone tops with our ThinSlabz[®] for a continued elegant design.



Standard sizes noted below.

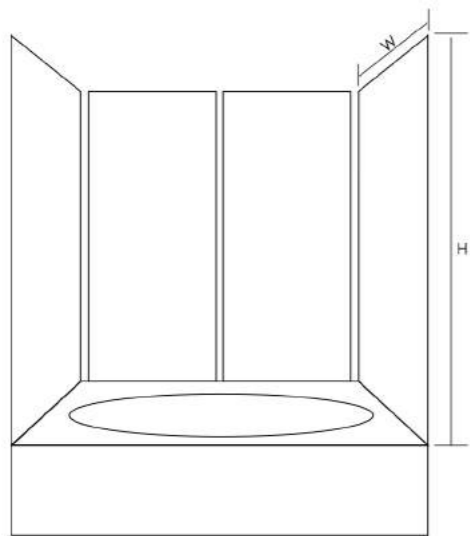
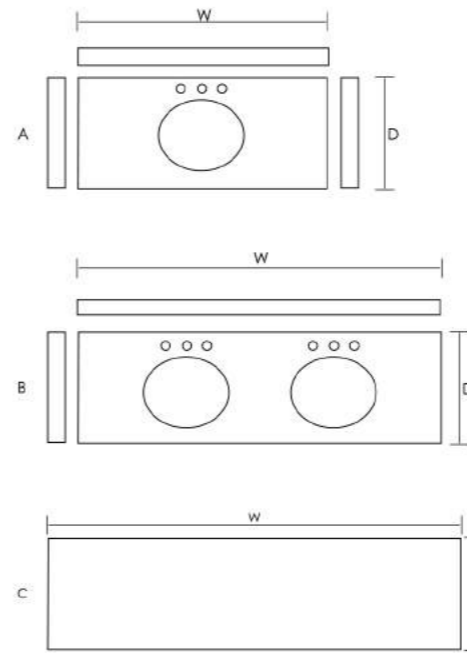

	W	H
1	30"	60"/72"/84"
2	32"	60"/72"/84"
3	60"	60"/72"/84"

	W	D
A	25"	22"
	37"	22"
	42"	22"
	49"	22"
B	60"	22"
	72"	22"
C	84"	22"
	96"	22"



THINSLABZ[®] BATHROOM ACCESSORIES



StoneVic International Inc. offers customized matching bathroom accessories and kits to compliment our beautiful ThinSlabz[®].

TRIM

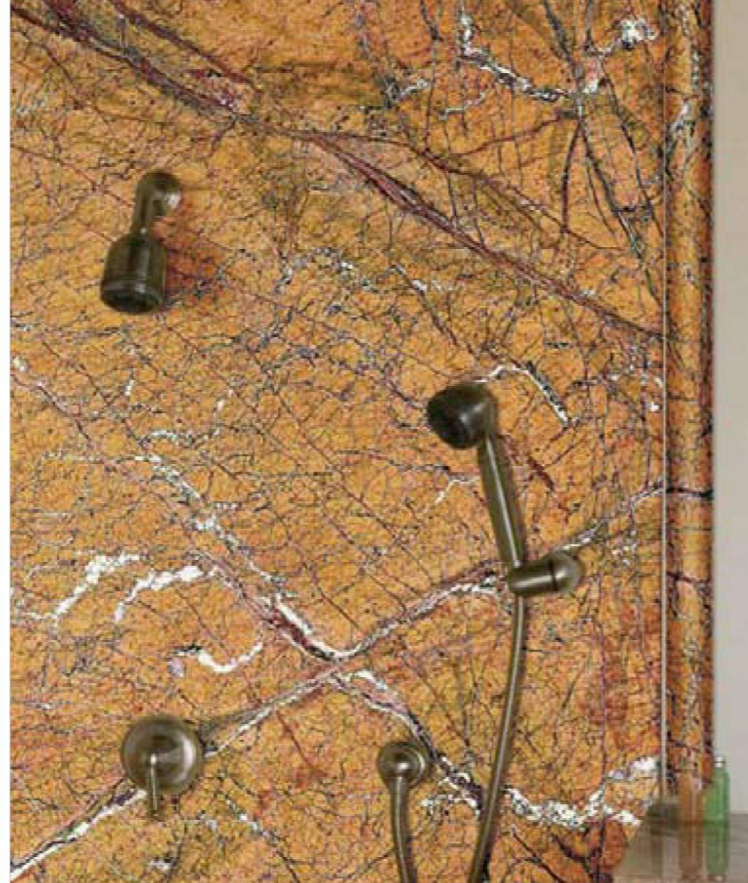

Marble Trim

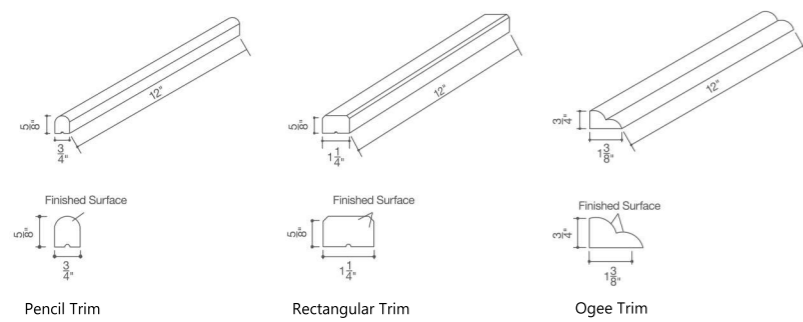

Granite Trim

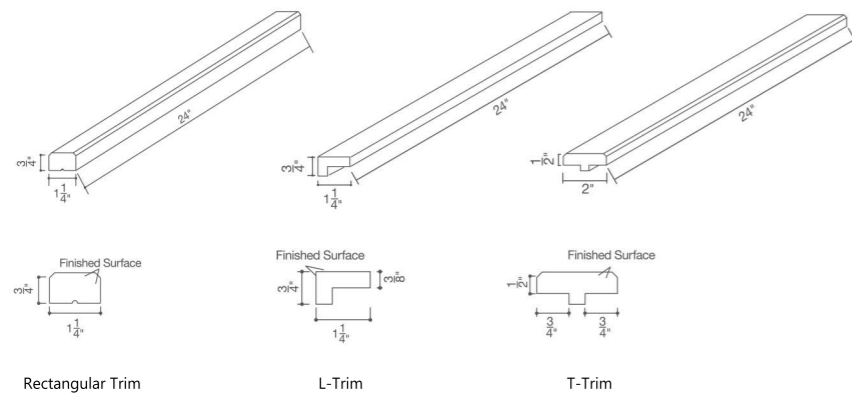

SOAP DISH

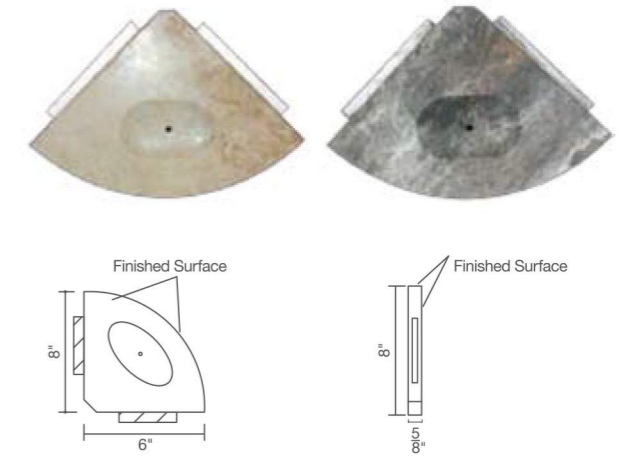

SOAP SHELF

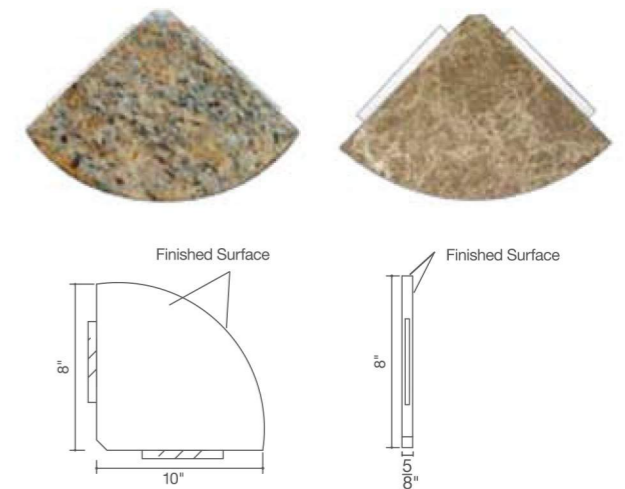
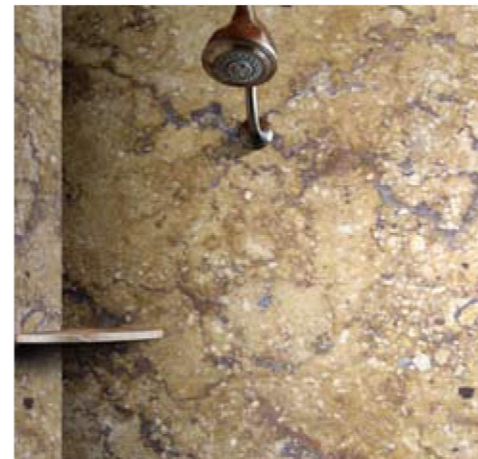

WALL BOX

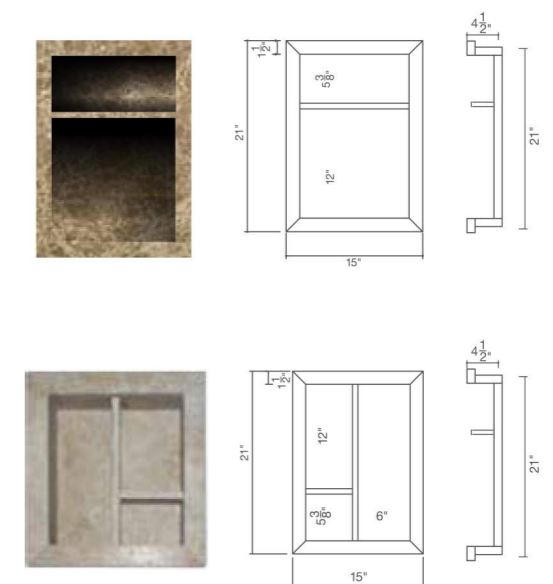

TILE

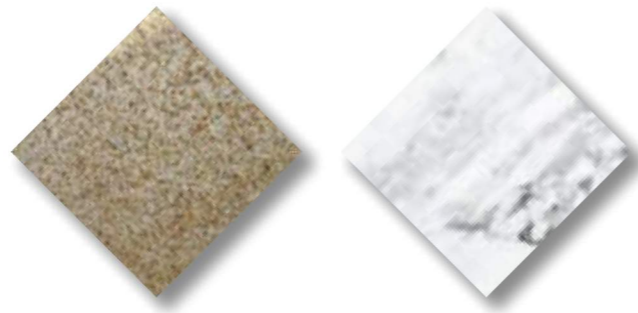
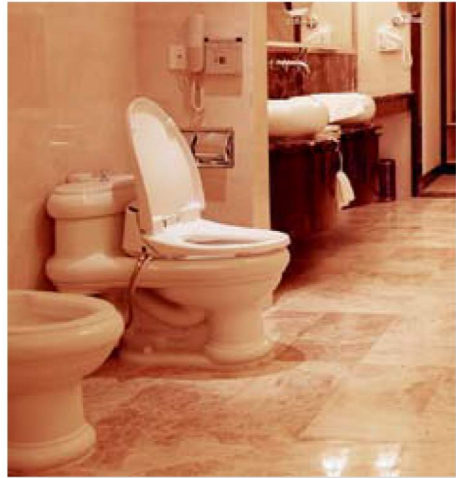

Tile Size:
12x12" 18x18" 12x24"

SHOWER PAN

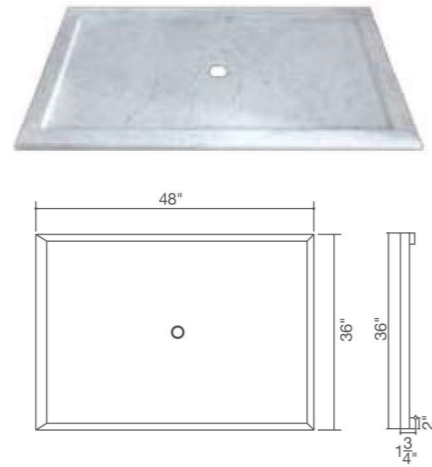

MOSAIC



INSTALLATION GUIDE

StoneVic International Inc. ThinSlabz[®] are an ideal choice for new construction, remodeling or repositioning projects.

ThinSlabz[®] can be applied directly over pre-existing surfaces, such as ceramic, stone and wood.

ThinSlabz[®] also minimize waste, lessen the cost of labor and saves on installation time.



1 Clean the existing surface.



2 Gule the panel directly to the existing wall surface.



3 Cover the StoneVic trim on the exposed edge profiles.



4 After installation.

GLUE



MARBLE



SIZE 1220x2440mm
1520x2440mm
1520x2600mm

☐ DUE TO THE NATURAL CHARACTERISTICS OF THE STONE, IT SHOULD BE NOTED THERE MAY BE A DIFFERENCE BETWEEN THE PHOTOS OR SAMPLES AND THE ACTUAL ARTICLES.

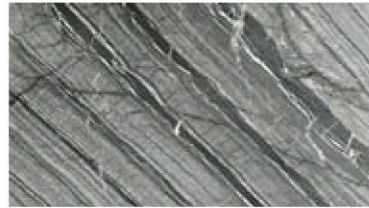

ANTIQUÉ WOOD



GOLDEN BROWN

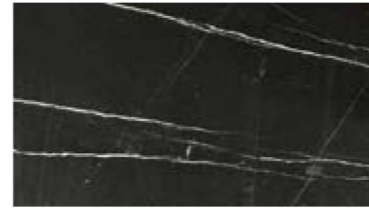

NERO MARQINO

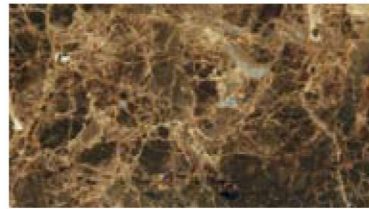

DARK EMPERADOR

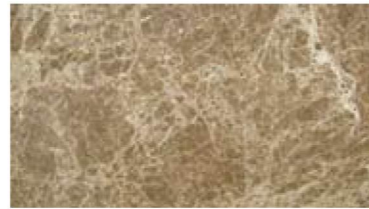

LIGHT EMPERADOR



TEAK WOOD WHITE



FRENCH MOCA



CREAM MARFIL



IVORY GOLD

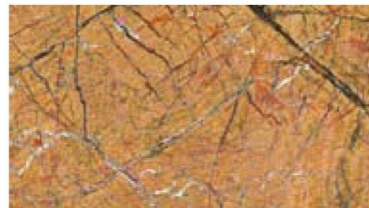

RAINFOREST BROWN



RAINFOREST GREEN

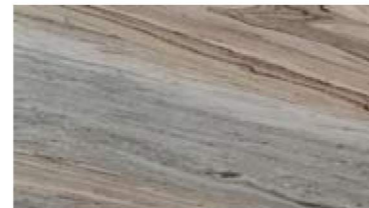

GREY GALAXY



LILAC WHITE



CARRARA WHITE



STATUARIO

TRAVERTINE



SIZE 1220x2440mm
1520x2440mm
1520x2600mm

☐ DUE TO THE NATURAL CHARACTERISTICS OF THE STONE, IT SHOULD BE NOTED THERE MAY BE A DIFFERENCE BETWEEN THE PHOTOS OR SAMPLES AND THE ACTUAL ARTICLES.



IVORY TRAVERTINE (V)



WALNUT TRAVERTINE (V)



NOCE TRAVERTINE (V)



IVORY TRAVERTINE (C)



WALNUT TRAVERTINE (C)



NOCE TRAVERTINE (C)



GOLD TRAVERTINE (V)



RED TRAVERTINE (V)



SILVER TRAVERTINE (V)



GOLD TRAVERTINE (C)

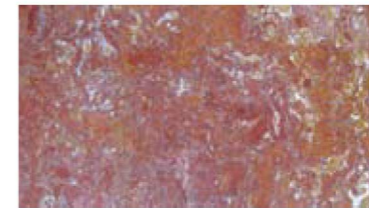

RED TRAVERTINE (C)



SILVER TRAVERTINE (C)

ONYX



SIZE 1220x2440mm
1520x2440mm
1520x2600mm

□ DUE TO THE NATURAL CHARACTERISTICS OF THE STONE, IT SHOULD BE NOTED THERE MAY BE A DIFFERENCE BETWEEN THE PHOTOS OR SAMPLES AND THE ACTUAL ARTICLES.



TRAVERTINE ONYX



BAMBOO ONYX

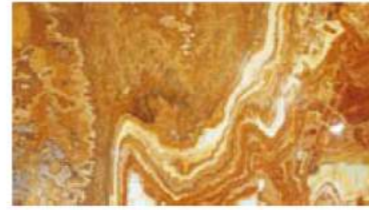

TIGER ONYX

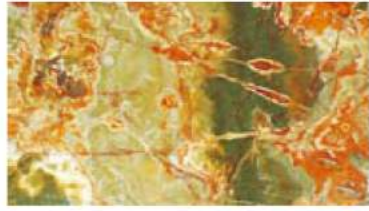

GREEN ONYX



RED DRAGON ONYX



HONEY ONYX



YELLOW ONYX



WHITE VEIN ONYX



WHITE FLOWER ONYX



WHITE ONYX



BLUE ONYX



GREY ONYX

GRANITE



SIZE 1220x2440mm

□ DUE TO THE NATURAL CHARACTERISTICS OF THE STONE, IT SHOULD BE NOTED THERE MAY BE A DIFFERENCE BETWEEN THE PHOTOS OR SAMPLES AND THE ACTUAL ARTICLES.



MAJESTIC MAUVE



GOLDEN PEACH



BALA FLOWER



BALTIC BROWN



UBATUBA

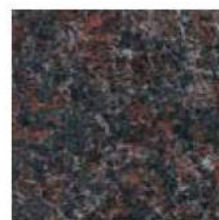

TAN BROWN



BLACK GALAXY



GIALLO ORNAMENTALE



GIALLO SANTA CECILIA



SANTA CECILIA DARK

LUXURIOUS STONE



SIZE 1220x2440mm
1520x2440mm
1520x2600mm

□ DUE TO THE NATURAL CHARACTERISTICS OF THE STONE, IT SHOULD BE NOTED THERE MAY BE A DIFFERENCE BETWEEN THE PHOTOS OR SAMPLES AND THE ACTUAL ARTICLES.



BIANCO ANTICO



IMPERIAL GOLD



PICASSO



BLUE SKY



AZUL BAHIA



GREEN QUARTZ

AGATE



SIZE 1200x2400mm

□ DUE TO THE NATURAL CHARACTERISTICS OF THE STONE, IT SHOULD BE NOTED THERE MAY BE A DIFFERENCE BETWEEN THE PHOTOS OR SAMPLES AND THE ACTUAL ARTICLES.



WHITE AGATE



YELLOW AGATE

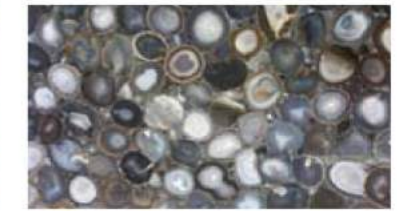

BLUE AGATE



COLORFUL AGATE



AMETHYST



RED AGATE

THINSLABZ[®] APPLICATION

ThinSlabz[®] have been adopted as ideal construction material in these years, our products have been applied in various construction, residential jobs both in domestic and overseas.

